

AENOR



Empresa Registrada

ER-1096/1998

AENOR



Gestión Ambiental

CGM-03/405

# MECAMAM

M



## ESTANTERÍAS MECAMAM





1-A

EXPOSITOR CON HALÓGENOS  
DISPLAY UNIT WITH HALOGEN LIGHTING



3-A

EXPOSITOR CON LUZ FLUORESCENTE  
DISPLAY UNIT WITH FLUORESCENT LIGHT



2-E

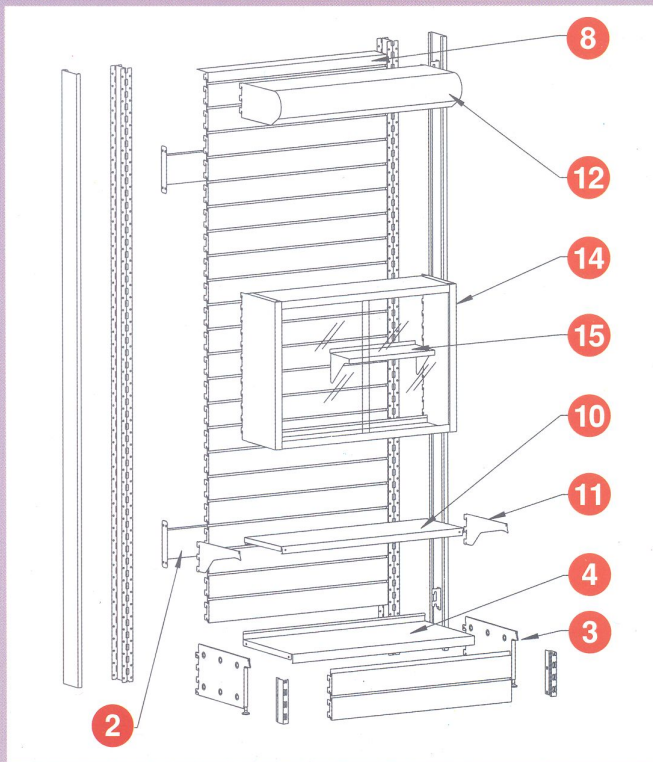

2-F

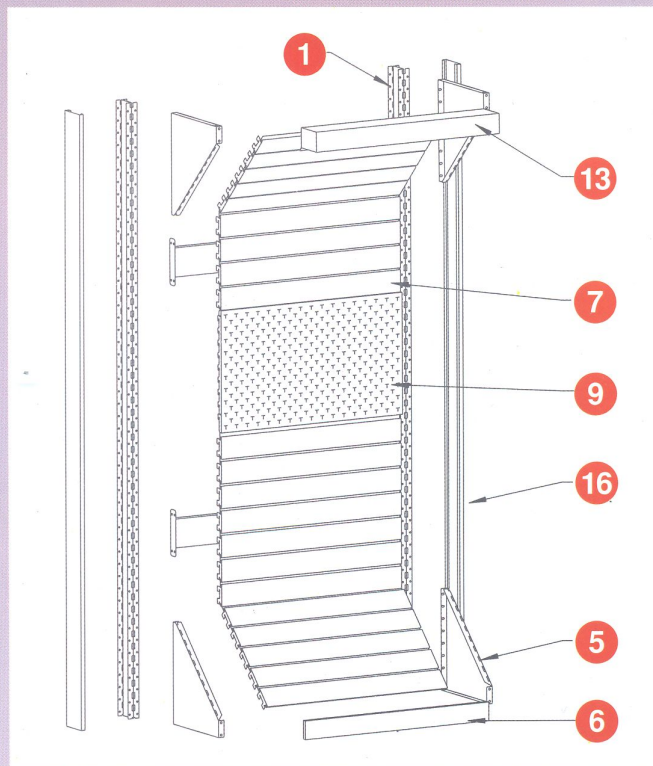

- 1** CREMALLERA "U" DE 80 expo (Ref. CR/U-80)  
"U-80" expo UPRIGHT PROFILE

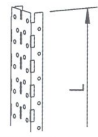

Longitud
1000 1200 1500 2000 2200 2500 3000

- 2** SEPARADOR expo  
expo SEPARATOR

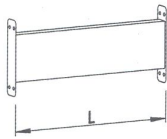

Longitud
450 650 850

- 3** Ref. PIE expo  
expo BASE PLATE

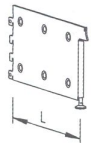

Longitud
300 400 500

- 4** BANDEJA INFERIOR PIE expo (Ref. BIP expo)  
expo BOTTOM SHELF PANEL

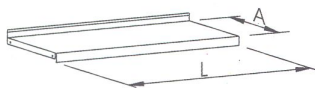

Longitud	Ancho
450 650 850	300 400 500

- 5** PIE/TECHO TRIANGULO expo  
expo TRIANGULAR TOP/BOTTOM



Longitud
400

- 6** ZÓCALO PIE TRIÁNGULO expo  
expo BOTTOM TRIANGLE SOCLE

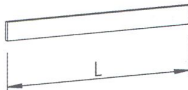

Longitud
450 650 850

- 7** LAMA expo  
expo PANEL

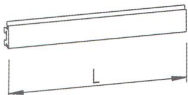

Longitud	Alto
450 650 850	100

- 8** LAMA SUPERIOR expo  
TOP expo PANEL

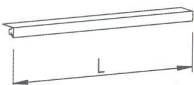

Longitud
450 650 850

- 9** FONDO PERFORADO expo  
expo SLOTTED PANEL

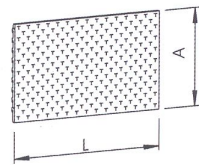

Longitud	Ancho
450 650 850	500

- 10** BANDEJA LISA expo (Ref. BL expo)  
expo SHELF PANEL



Longitud	Ancho
450 650 850	200 300 400

- 11** CARTELA BANDEJA LISA expo (Ref. CBL expo)  
expo SHELF PANEL END BRACKET



Longitud
200 300 400

- 12** MARQUESINA expo  
expo LIGHT CANOPY



Longitud
450 650 850

- 13** MARQUESINA HALÓGENA expo  
expo HALOGEN LIGHT CANOPY

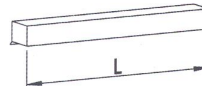

Longitud
450 850

- 14** VITRINA expo  
expo DISPLAY CASE

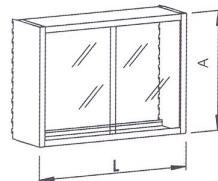

Longitud	Altura	Fondo
850	600	250

- 15** BANDEJA VOLADIZO expo  
expo CANTILEVER SHELF PANEL

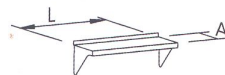

Longitud	Ancho
400	150

- 16** MARCO LATERAL U-80 expo  
expo U-80 UPRIGHT PROFILE COVER

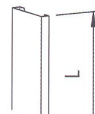

Longitud
1000 1200 1500 2000 2200 2500 3000

ACCESORIOS:

GANCHO expo  
expo HOOK



GANCHO FONDO PERF.  
HOOKS FOR SLOTTED PANEL



\*PARA COLGAR PERCHAS  
STAND FOR RACKS  
\*PARA NEUMÁTICOS  
STAND FOR TYRES

\*PARA LLANTAS  
STAND FOR RIMS  
\*PARA AMORTIGUADORES...  
STAND FOR SHOOKS...

# INDUSTRIAS MAM, S.A.

FÁBRICA Y OFICINAS

POLÍGONO INDUSTRIAL VIRGEN DE LA SALUD, PARCELA 16 - TEL. 96 379 88 35 - FAX: 96 370 76 48  
APDO. 83 - 46950 - CHIRIVELLA (VALENCIA) - (ESPAÑA)

E.mail: [mecamam@mecamam.com](mailto:mecamam@mecamam.com) - Internet: <http://www.mecamam.com>

