

ESTANTERÍAS MECAMAM

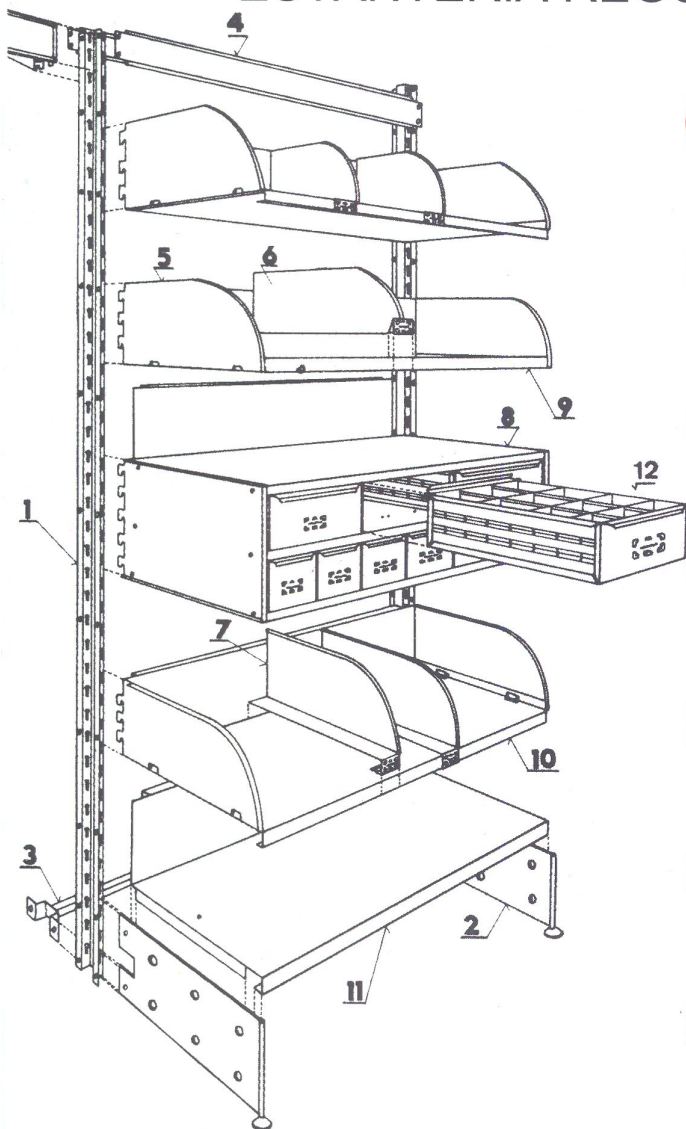





ACCESORIOS :

* Tornillo con tuerca



Acabado: Sup. cincada

* Bandera señalización calles

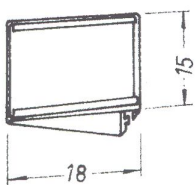

Acabado: Sup. pintada en amarillo

* Divisores cajón

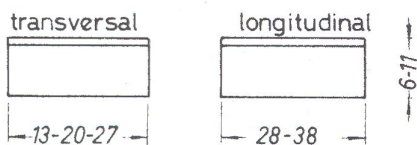

Acabado: Sup. pintada en gris perla

1 CREMALLERA regulable

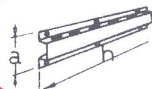

ancho		altura		
10,5	200	220	250	300

2 PIE base

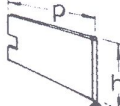

altura	profund.
15	30 40

3 UNIÓN inferior cremallera



altura	ancho
3,0	87

4 UNIÓN superior cremallera

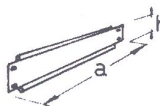

altura	ancho
7,5	87

5 CARTELA regulable



altura	profundidad
14	30 40

6 TABICA bandeja contenedor

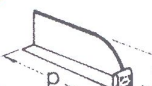

altura	profundidad
14	30 40

7 TABICA bandeja lisa

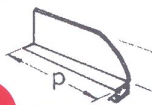

altura	profundidad
14	30 40

8 KIT BANDEJAS para cajones



ancho	profund.	altura
85	30 40	30

9 BANDEJA contenedor



ancho	profundidad
85	30 40

10 BANDEJA lisa



ancho	profundidad
85	30 40

11 BANDEJA de pie



ancho	profund.
85	30 40

12 CAJON clasificador

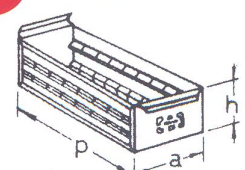

profund.		ancho		altura	
30	40	14	21	28	7

INDUSTRIAS MAM, S.A.

FÁBRICA Y OFICINAS

POLÍGONO INDUSTRIAL VIRGEN DE LA SALUD, PARCELA 16 - TEL. 96 379 88 35 - FAX: 96 370 76 48

APDO. 83 - 46950 - CHIRIVELLA (VALENCIA) - (ESPAÑA)

E.mail: mecamam@mecamam.com - Internet: <http://www.mecamam.com>

