

# MAM

ESTANTERIAS MECAMAM

CASILLEROS Y ESTANTERIAS DE ACERO

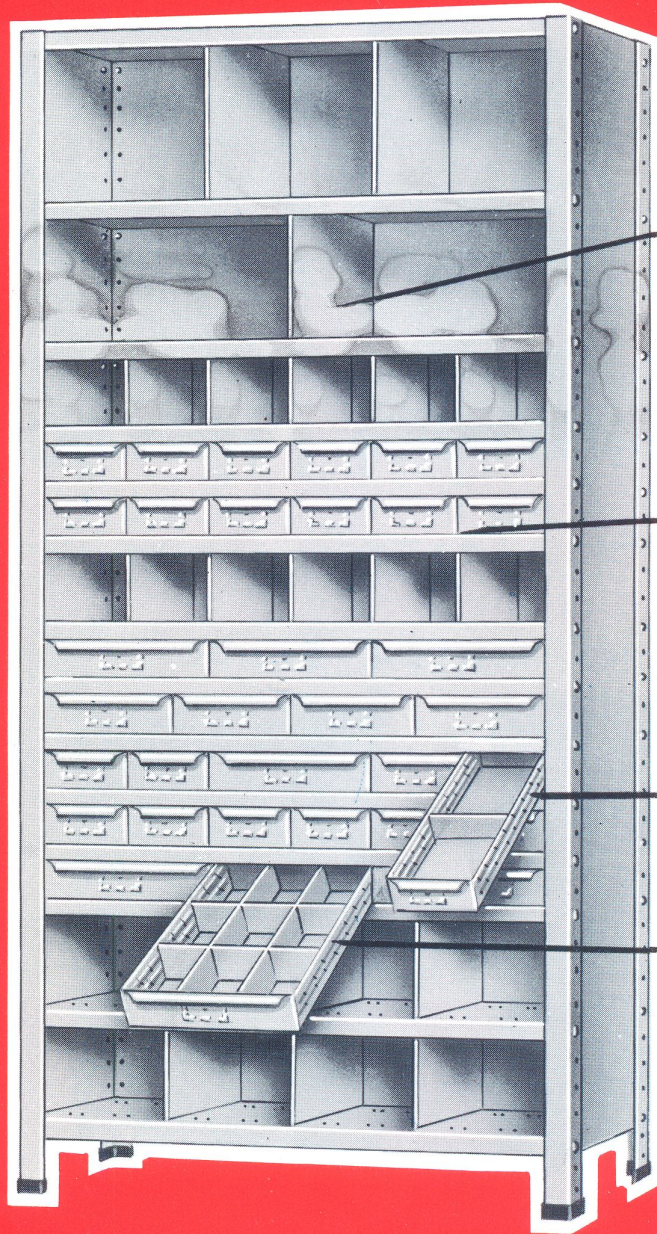



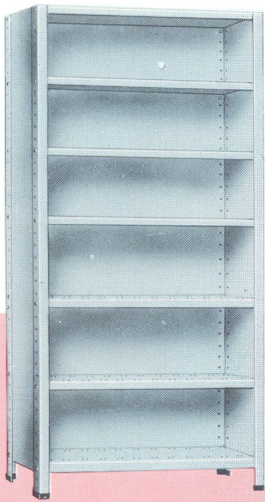

MOD. 101

3 Casillas	35 x 915
3 "	30 x 915



MOD. 102

6 Casillas	300 x 305
2 "	300 x 457
3 "	350 x 305
4 "	350 x 457

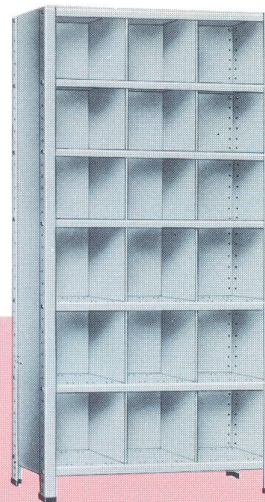

MOD. 103

9 Casillas	300 x 305
9 "	350 x 305

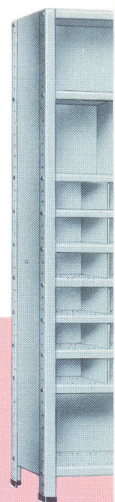

MOD. 104

4 Casillas	
3 "	
24 "	

### DIMENSIONES NORMALES DE

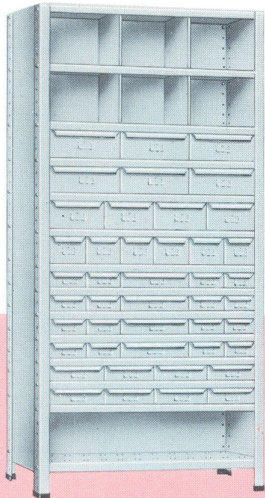

MOD. 108

6 Casillas	250 x 305	3 Cajones	C-30/G-7
1 "	250 x 915	8 "	C-30/M-7
6 Cajones	C-30/G-12	16 "	C-30/P-7
4 "	C-30/M-12		
6 "	C-30/P-12		

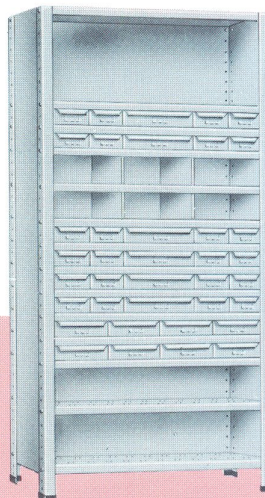

MOD. 109

1 Casillas	400 x 915	6 Cajones	C-30/G-7
1 "	200 x 915	8 "	C-30/M-7
1 "	250 x 915	24 "	C-30/P-7
6 "	150 x 305		

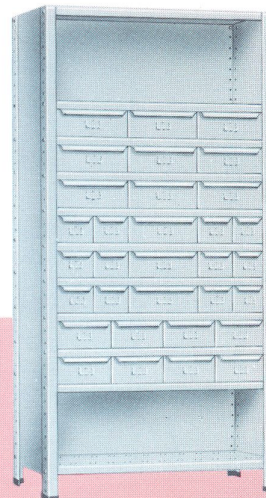

MOD. 110

1 Casilla	40 x 915
1 "	35 x 915
12 Cajones	C-30/G-12
8 "	C-30/M-12
12 "	C-30/P-12

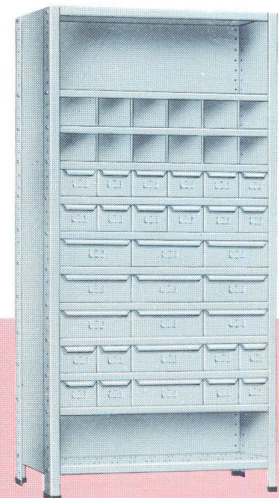

MOD. 111

1 Casilla	350 x 915
1 "	250 x 915
12 "	140 x 150
11 Cajones	C-30/G-12
20 "	C-30/P-12

### 2'10 METROS DE ALTO, 92 CM. DE ANCHO

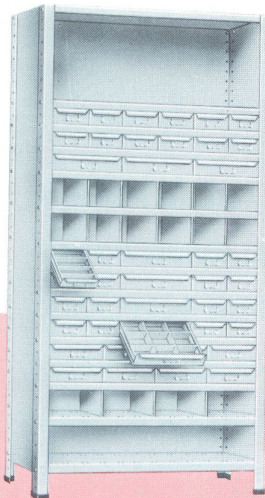

MOD. 116

1 Casilla	400 x 915	7 Cajones	C-30/G-12
1 "	200 x 915	8 "	C-30/M-12
12 "	150 x 140	28 "	C-30/P-12
4 "	150 x 210		



MOD. 117

1 Casilla	350 x 915	4 Cajones	C-30/G-12
4 "	250 x 290	8 "	C-30/M-12
12 "	150 x 140	16 "	C-30/P-12

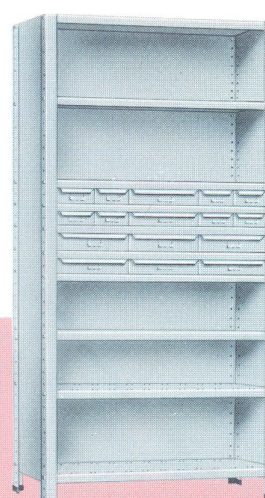

MOD. 118

3 Casillas	350 x 915
2 "	250 x 915
8 Cajones	C-30/G-7
8 "	C-30/P-7

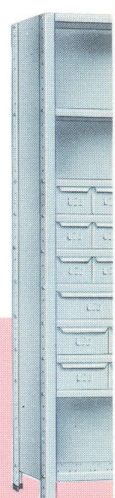

MOD. 119

1 Casilla	400 x 915
1 "	350 x 915
1 "	300 x 915



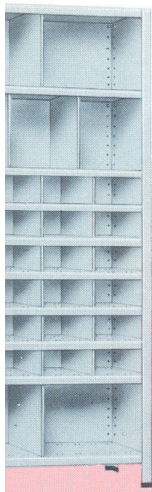

MOD. 104

3 Casillas 350 x 457  
1 " 350 x 305  
150 x 228

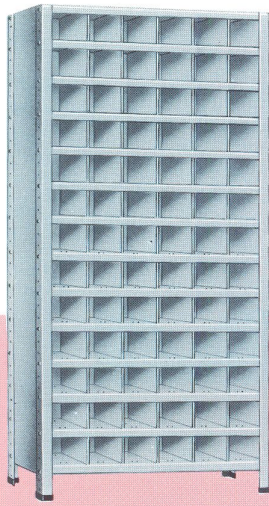

MOD. 105

78 Casillas 150 x 152

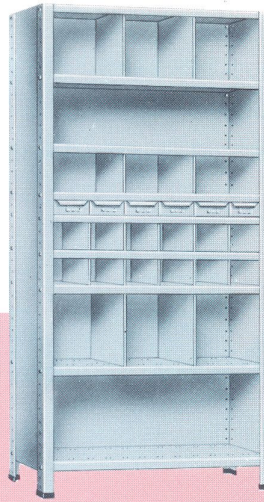

MOD. 106

3 Casillas 300 x 305 3 Casillas 350 x 305  
1 " 300 x 915 1 " 400 x 915  
3 " 200 x 305 6 Cajones C-30/P-7  
12 " 150 x 152

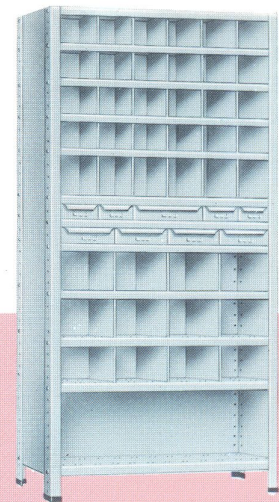

MOD. 107

24 Casillas 150 x 152 4 Cajones C-30/P-7  
6 " 200 x 152 1 " C-30/G-7  
12 " 200 x 228 4 " C-30/M-7  
1 " 350 x 915

## TODAS NUESTRAS UNIDADES,

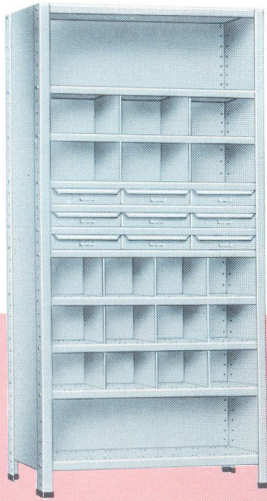

MOD. 112

1 Casilla 350 x 915  
1 " 300 x 915  
6 " 200 x 280  
12 " 200 x 210  
9 Cajones C-30/G-7

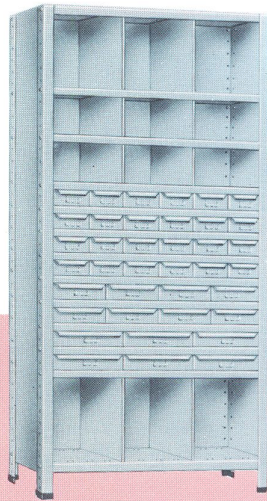

MOD. 113

3 Casillas 400 x 280 6 Cajones C-30/G-7  
3 " 350 x 280 8 " C-30/M-7  
6 " 200 x 280 24 " C-30/P-7

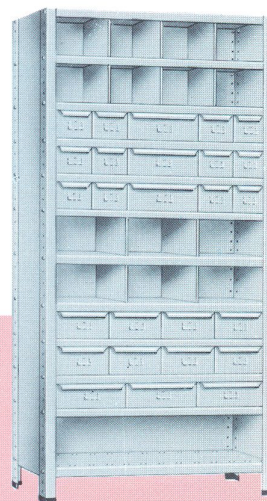

MOD. 114

1 Casilla 250 x 915 6 Cajones C-30/G-12  
6 " 200 x 280 8 " C-30/M-12  
8 " 200 x 210 12 " C-30/P-12

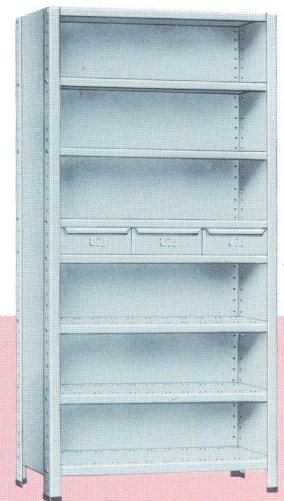

MOD. 115

6 Casillas 300 x 915  
3 Cajones C-30/G-12

## DE ANCHO, 30 ó 40 CM. DE FONDO

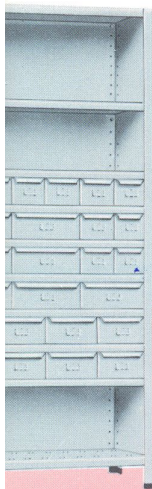

MOD. 119

5 5 Cajones C-30/G-12  
5 8 " C-30/M-12  
5 14 " C-30/P-12

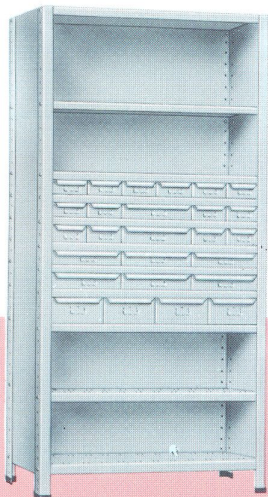

MOD. 120

1 Casilla 400 x 915  
3 " 300 x 915  
8 Cajones C-30/G-7  
14 " C-30/P-7  
4 " C-30/M-12

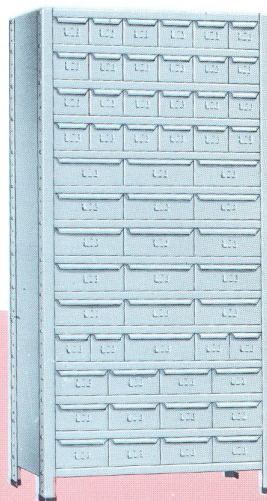

MOD. 121

16 Cajones C-30/G-12  
12 " C-30/M-12  
28 " C-30/P-12

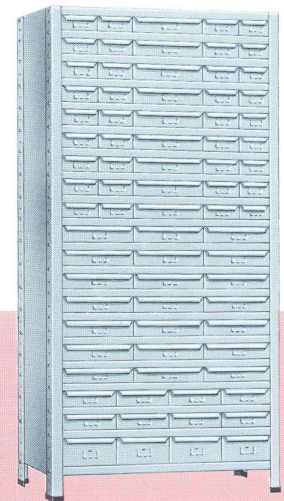

MOD. 122

30 Cajones C-30/G-7  
8 " C-30/M-7  
36 " C-30/P-7  
4 " C-30/M-12



# CASILLEROS DE ACERO DESMONTABLES

Para entrega inmediata...

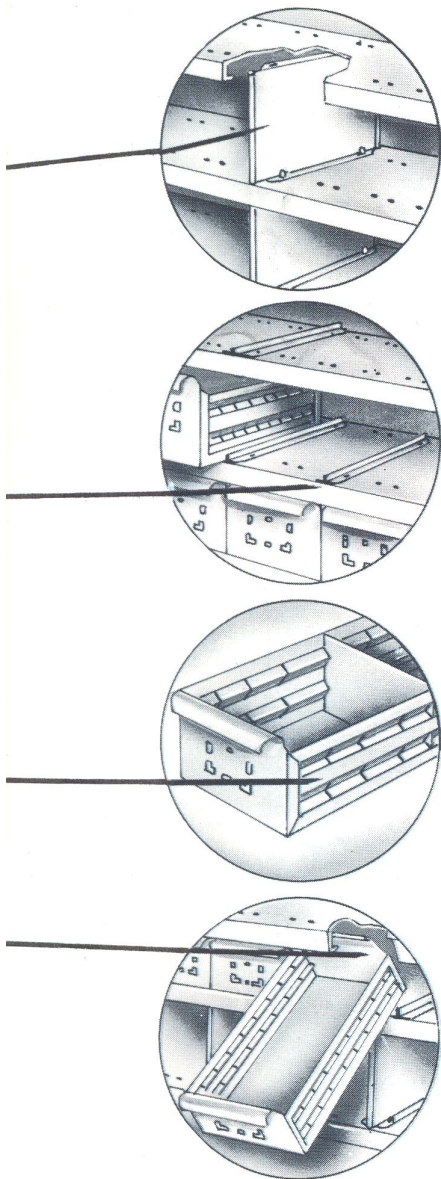

EJEMPLO DE ENSAMBLE DE GUIAS, CAJONES, TABICAS Y DIVISORES PARA LA FORMACION DE UNA ESTANTERIA-CASILLERO "M E C A M A M".

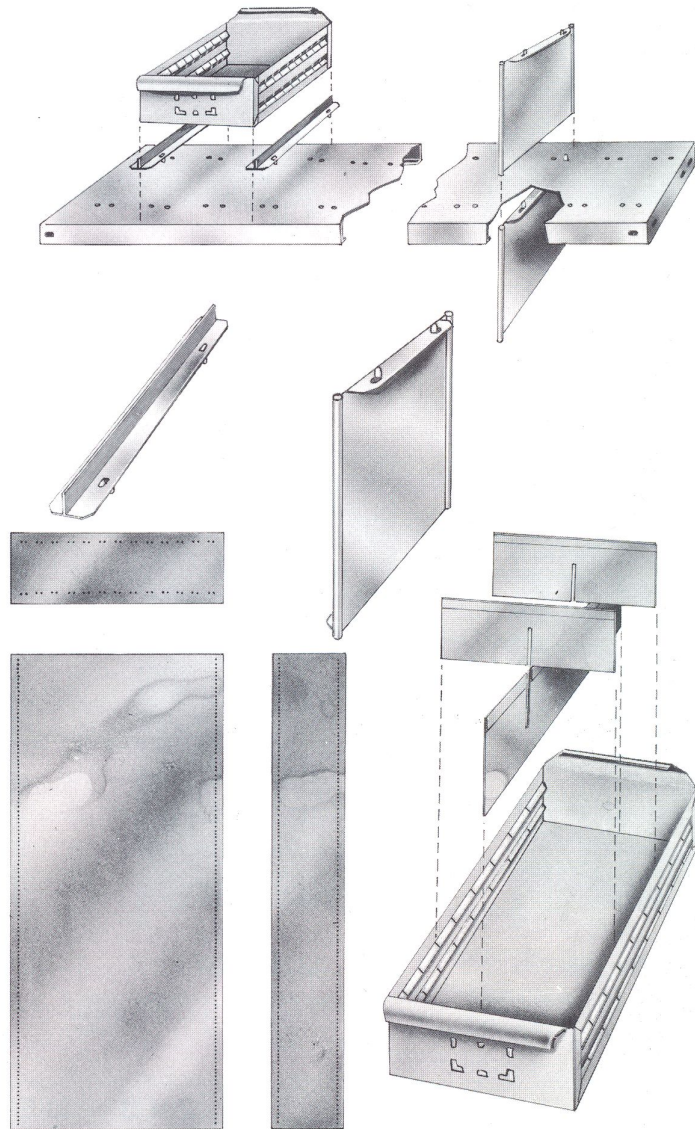

PARA

- REPUESTOS AUTOMOVILES
- FERRETERIAS
- REPUESTOS TEXTILES
- OFICINAS
- FARMACIAS
- ACCESORIOS RADIO y T. V.
- LABORATORIOS OPTICOS
- FABRICAS Y CLASIFICACION GENERAL, ETC.

**VD. PUEDE FORMAR CUALQUIER COMBINACION ACOPLANDO PANELES, TABICAS Y CAJONES A SU MEDIDA Y NECESIDAD.**



**SERIE DE ACCESORIOS PARA ESTANTERIA-CASILLERO "MECAMAM". (Modelos patentados).**

**TABICAS SEPARADORAS DE 30 cm.**

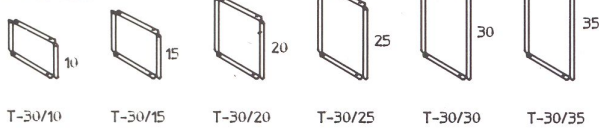

**TABICAS SEPARADORAS DE 40 cm.**

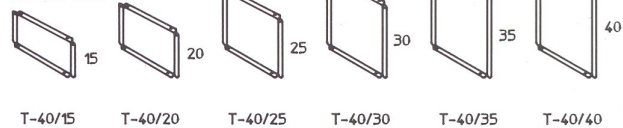

**PANELES PERFORADOS**

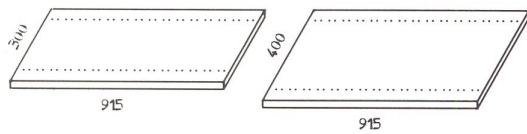

**GUIAS**

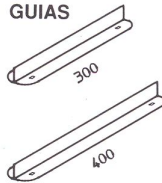

**DIVISIONES DE CAJON APLICADAS**

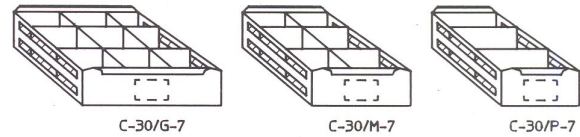

**FONDOS LATERALES**

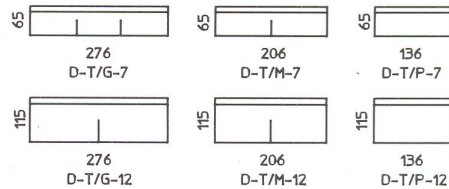
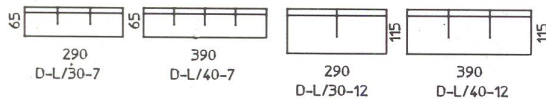
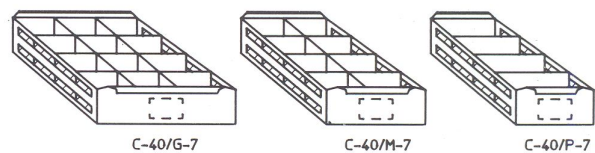
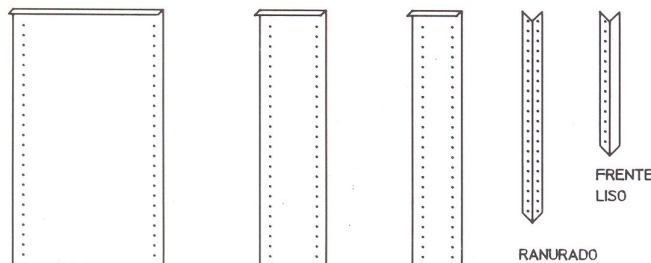

**CAJONES 7**

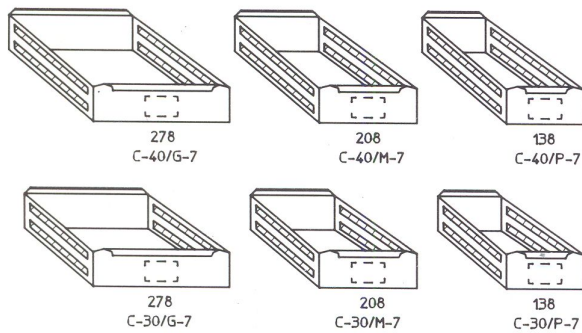

**CAJONES 12**

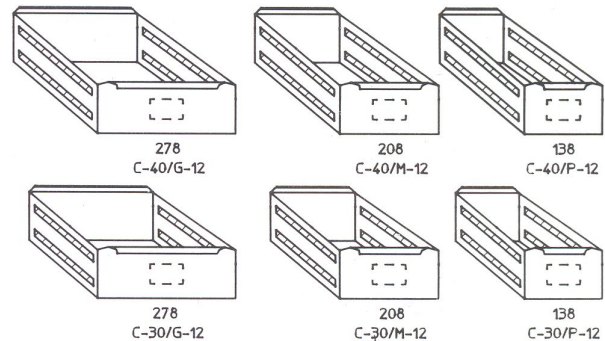

LOS MODELOS REPRESENTADOS EN LA PAGINA DE LA IZQUIERDA ESTAN MONTADOS A TITULO INFORMATIVO PARA SERVIR DE ORIENTACION EN FORMA Y PRECIO.

SI ESTOS NO SE ACOMODAN A SUS NECESIDADES PUEDEN MONTARSE SEGUN LAS INSTRUCCIONES QUE NOS INDIQUEN CON ARREGLO A SUS EXIGENCIAS DE ESPACIOS.

DISPONEMOS DE PUERTAS STANDAR CON CIERRE, ACOPLADAS A CUALQUIER MODULO.



# INDUSTRIAS MAM, S.A.

## FABRICA Y OFICINAS

POLIGONO INDUSTRIAL VIRGEN DE LA SALUD, PARCELA 16 - TEL. 379 88 35 - FAX (96) 370 76 48 - APDO. 83  
46950 - CHIRIVELLA (VALENCIA)

[mecamam@mecamam.com](mailto:mecamam@mecamam.com)

